

Zone 5 Materials Required:

Kinder squares

Two different coloured 10 sided dice, for pairs of students

10 x 10 grids

1 mm graph paper

2 metre measuring tapes

Rope, pegs and blank cards

Counters

One 250g block of chocolate wrapped in newspaper

1cm grid paper

Sandwich Task

Gina's Pizza Task

Blank Tree Diagram sheet

Sandwich Task

Nick's dad is making him a sandwich to take to school for lunch. He can choose one ingredient from each category:

White or brown bread

Margarine or butter

Tomato, cheese or lettuce

How many different sandwiches can he make?

Gina's Pizza

You've just begun working at Gina's Pizza Shop. She's a fussy boss and you know you will have to work quickly and accurately to keep your job.

Customers can order pizzas with:

a thick or thin crust

tomato or barbecue sauce

salami or olive or mushroom toppings

A family comes into the shop. How many different pizzas are possible?

10 x 10 Grids

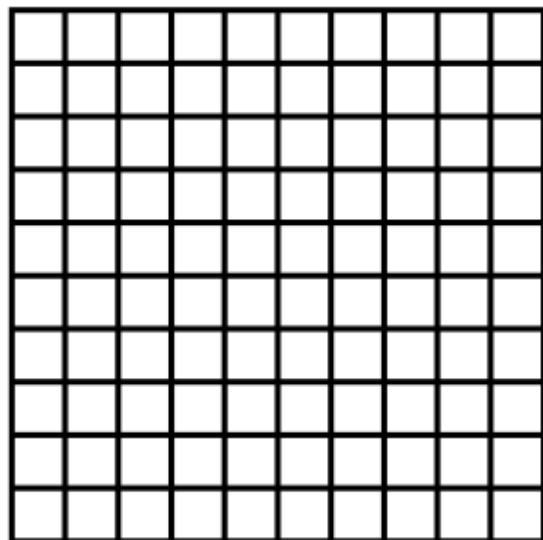
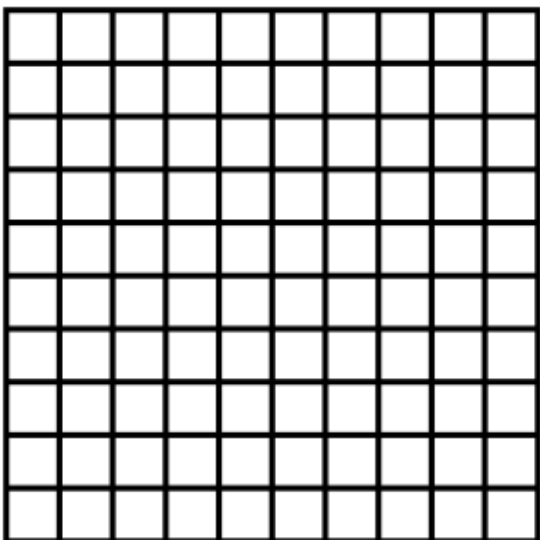
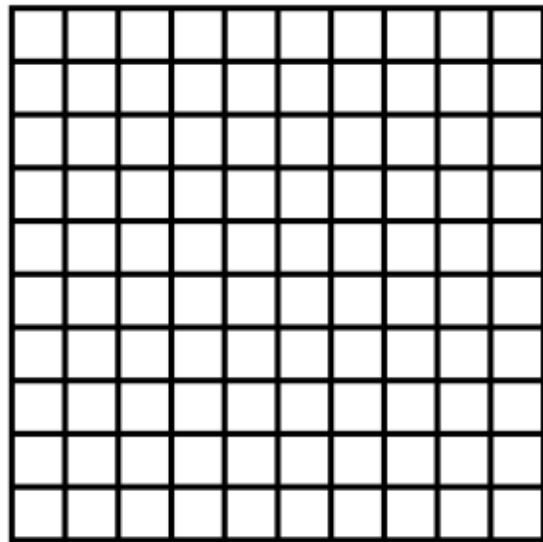
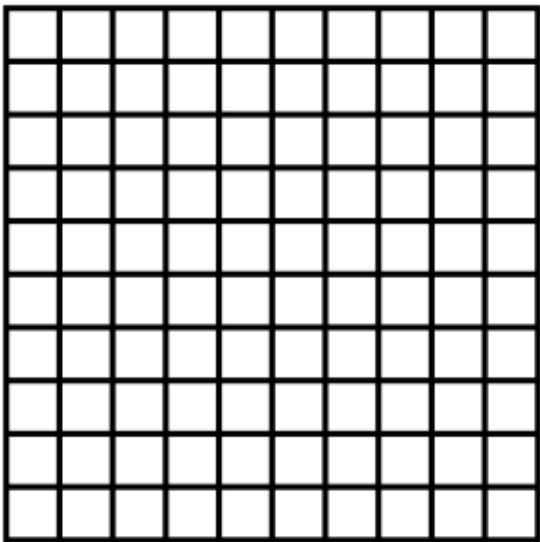
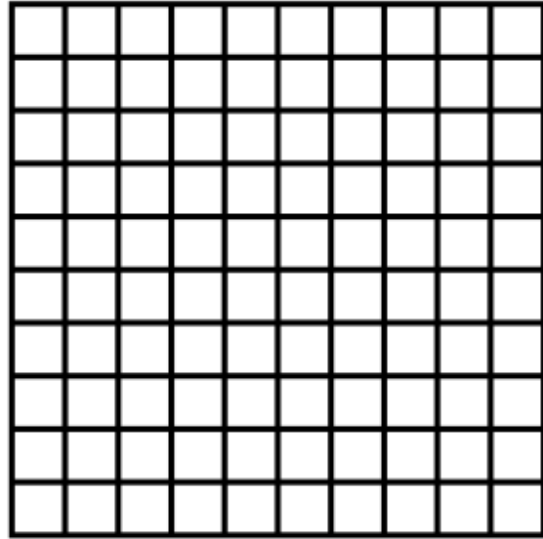
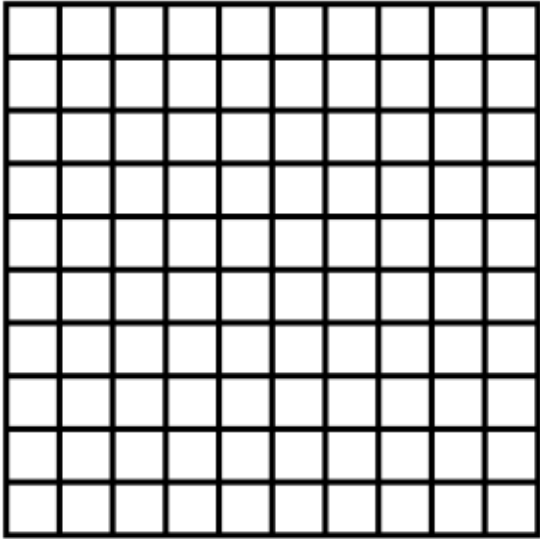

BLANK TREE DIAGRAM

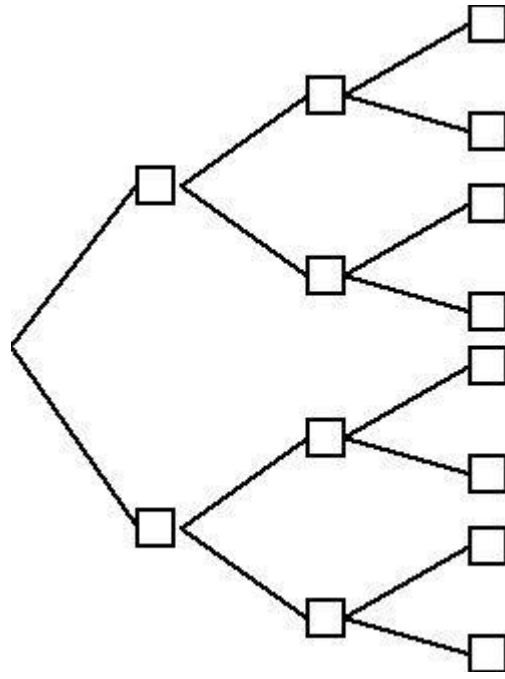

1cm Grid Paper

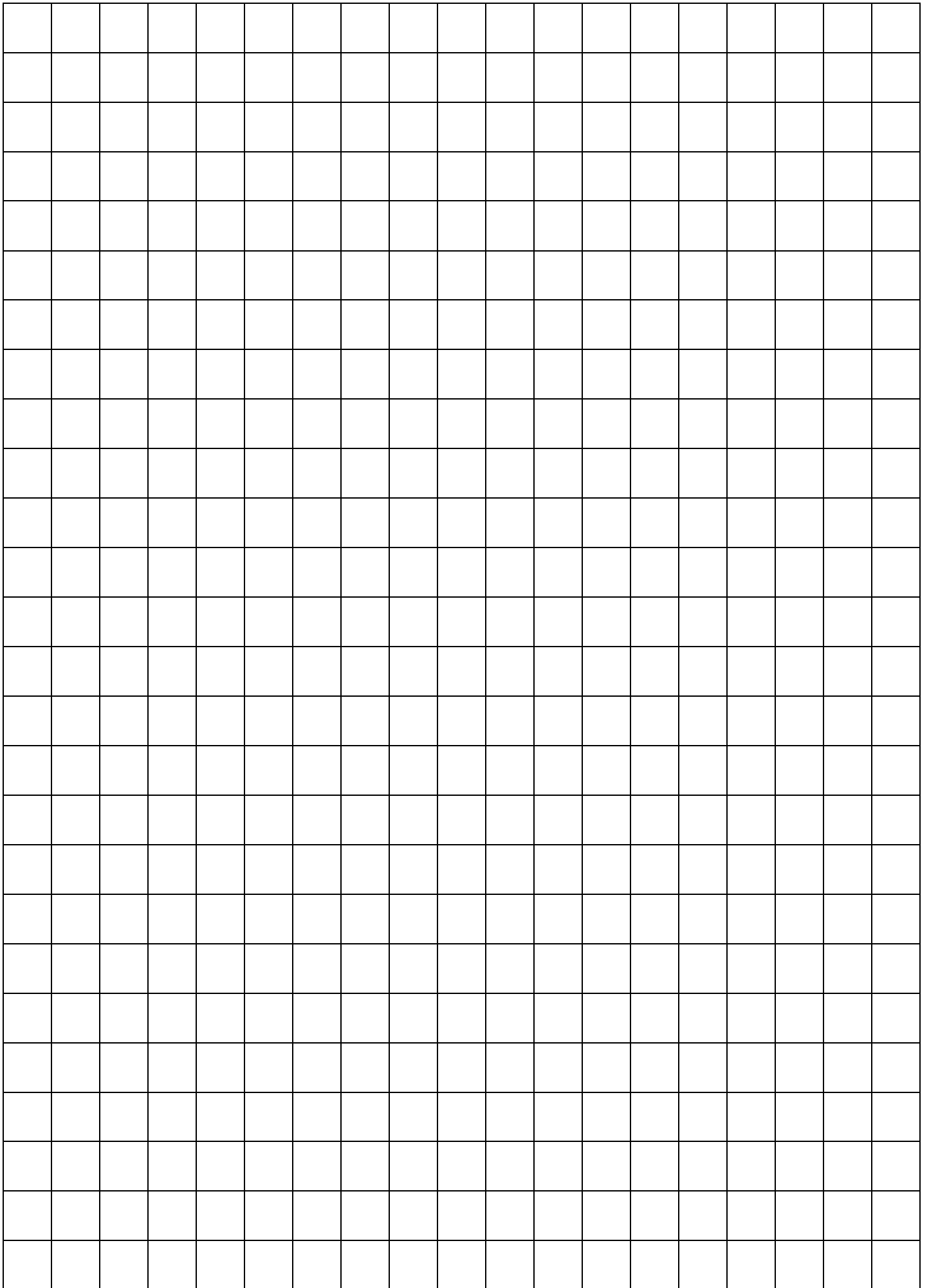

2cm Grid Paper

